

## ISTRUZIONI DI MONTAGGIO

FITTING INSTRUCTIONS  
INSTRUCTIONS DE MONTAGE  
MONTAGEANLEITUNG  
INSTRUCCIONES DE MONTAJE  
ИНСТРУКЦИЯ ПО УСТАНОВКЕ

|   |   |            |            |             |             |              |              |
|---|---|------------|------------|-------------|-------------|--------------|--------------|
| DISPOSITIVO DI TRAINO TIPO<br>TOWING DISPOSAL TYPE<br>TYPE DU DISPOSITIF DE REMORQUAGE<br>ANHÄNGERVORRICHTUNG TYP<br>DISPOSITIVO DE CAREO TIPO<br>ТЯГОВО-ЦЕПНОЕ УСТРОЙСТВО  | <b>15015</b>  |            |            |             |             |              |              |
| PER AUTOVEICOLI<br>FOR CARS<br>POUR VÉHICULES AUTOMOBILES<br>FÜR KRAFTFAHRZEUGE<br>PARA AUTOVEHICULO<br>ДЛЯ АВТОМОБИЛЕЙ   | <b>HONDA JAZZ</b><br>2008 =><br>(GG1, GG2, GG3)   |            |            |             |             |              |              |
| CLASSE E TIPO DI ATTACCO<br>CLASS AND HITCH TYPE<br>CLASSE ET TYPE DE CROCHET<br>KLASSE UND BEFESTIGUNGSART<br>CLASES DE ACOPLAMIENTO<br>КЛАСС И ТИП СОЕДИНЕНИЯ   | F   |            |            |             |             |              |              |
| OMOLOGAZIONE<br>HOMOLOGATION<br>HOMOLOGATION<br>ZULASSUNG<br>APROBACION<br>ОМОЛОГАЦИЯ   | e3 00 – 7493<br>(DIR. 94/20/CE)   |            |            |             |             |              |              |
| CARICO VERTICALE MAX<br>S VALUE<br>MASSE VERTICALE MAXIMUM<br>ZUL. STUETZLAST<br>CARGA MAX. VERTICAL<br>МАКСИМАЛЬНАЯ ВЕРИКАЛЬНАЯ НАГРУЗКА   | S = kg 95   |            |            |             |             |              |              |
| VALORE D<br>D VALUE<br>VALEUR D<br>D WERT<br>VALOR D<br>ЗНАЧЕНИЕ  | $D = \frac{\begin{matrix} \text{Max } \downarrow \text{ Kg} & & \text{Max } \downarrow \text{ Kg} \\ \text{---} & \times & \text{---} \\ \text{---} & & \text{---} \end{matrix}}{\begin{matrix} \text{Max } \downarrow \text{ Kg} & & \text{Max } \downarrow \text{ Kg} \\ \text{---} & + & \text{---} \\ \text{---} & & \text{---} \end{matrix}} \times 0,00981 \leq 9,5 \text{ kN}$ |            |            |             |             |              |              |
| COPPIA DI SERRAGGIO PER VITI (8.8):<br>TORQUE SETTINGS FOR NUTS AND BOLTS (8.8):<br>COUPLE DE SERRAGE POUR VIS (8.8):<br>SCHRAUBENANZUGSMOMENT (8.8):<br>MOM. DE PRESION PARA TORNILLOS Y TUERCAS (8.8):<br>СПИСОК ДЕТАЛЕЙ (8.8): | <table> <tr> <td>M6 = 10 Nm</td> <td>M8 = 25 Nm</td> </tr> <tr> <td>M10 = 55 Nm</td> <td>M12 = 85 Nm</td> </tr> <tr> <td>M14 = 135 Nm</td> <td>M16 = 200 Nm</td> </tr> </table>   | M6 = 10 Nm | M8 = 25 Nm | M10 = 55 Nm | M12 = 85 Nm | M14 = 135 Nm | M16 = 200 Nm |
| M6 = 10 Nm  | M8 = 25 Nm  |            |            |             |             |              |              |
| M10 = 55 Nm   | M12 = 85 Nm   |            |            |             |             |              |              |
| M14 = 135 Nm  | M16 = 200 Nm  |            |            |             |             |              |              |

## **SAFETY INSTRUCTIONS**

- ◆ Make sure that the tow bar is suitable for the vehicle before starting the installation. Verify that the vehicle's towing disposal quoted on the car registration at the points D.1/ D.2 is mentioned on the tow bar document. Otherwise ask the proper office for explanation or updated documents.
- ◆ For safety, all work involving tow bar installation must be undertaken by skilled technicians.
- ◆ Damaged components must be replaced with manufacturer's spares parts by qualified staff.
- ◆ It is forbidden to make any modification or structural repair to the tow bar.

## **USE AND MAINTENANCE**

- ◆ The tow ball must be kept clean and lubricated. For added safety, his diameter (50 mm) must be checked at regular intervals. If the tow ball measures less than 49 mm after selected readings across the diameter, the tow ball must be replaced with a new one.
- ◆ After 1000 km of towing, check torque settings for nuts and bolts, in accordance with the table.

## **CAUTION**

The tow bar installer must fix at the same level with the ball in a clear position, a plate with the ball's maximum load for the vehicle on which the tow bar is fitted.

# FITTING INSTRUCTIONS

## 15015





Remove below the vehicle any mastic from contact points between the chassis and the tow bar; then paint mastic free pieces with rust inhibitor.

1. Remove the rear bumper and eliminate the reinforcement bar;
2. Remove the floor, the right and left side and the rear part of the boot's internal coating;
3. Drill the holes "1" and "6" with the bit of  $\varnothing 11$ , while widen the existing hole in position "5" with the bit of  $\varnothing 18$  on the upper part;
4. Insert the spacers "E" and "F", from underneath the chassis-rail, inside of the holes "1" and "2", place the tie rod "A", insert the screws and fix them interposing the washers;
5. Place the bracket "D" lined up with the rear part and the external side of the tie rod "A" referring to the holes "3" and "7" and fix them only in position "3";
6. Insert the spacer "F" from the top of the chassis-rail referring to the hole "5";
7. Place the frame "H" between the tie rod "A" and on the right chassis-rail referring to the holes "5", "6" and "7" and fix it only in position "7";
8. Place the counter-plate "C" under the chassis-rail; insert the screw "5" and fix;
9. Insert the spacer "F" in position "4" from above; place the bracket "B" referring to the holes "4" and "6"; insert and fix the screws interposing the spacer "G" in position "6";
10. Tighten thoroughly all bolts and nuts as shown in the enclosed layout;
11. Connect the wirings to the socket, following the car booklet's instructions "*use and maintenance*" and the positions as shown in the enclosed wiring kit layout;
12. Make a cut on the bumper's central part as shown in the enclosed layout;
13. Back together the floor, the right and left side and the rear part of the boot's internal coating;
14. Back together the rear bumper.

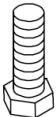
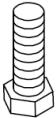
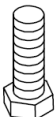
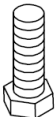

UMBRA RIMORCHI  
S. SISTO - PERUGIA

# KIT BULLONERIA COD. 15015

|   |                  |  |    |
|---|------------------|--|----|
|  X 7   | M10              |  X 1 | M8 |
|  X 2   | ROND.Ø40 PER M10 |  |    |
|  X 4   | M10x100          |  |    |
|  X 2   | M10x35           |  |    |
|  X 1   | M10x40           |  |    |
|  X 1 | M8x25            |  |    |
|  X 7 | M10              |  |    |

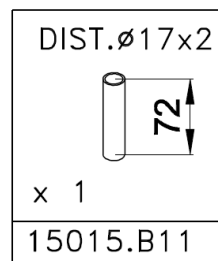
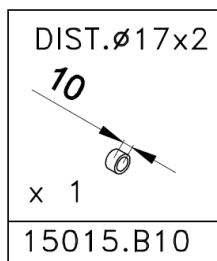
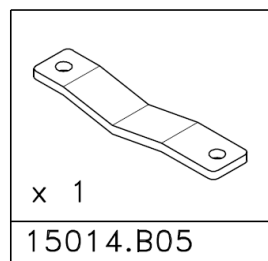
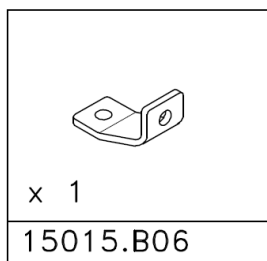
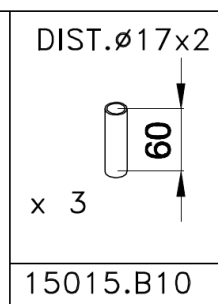
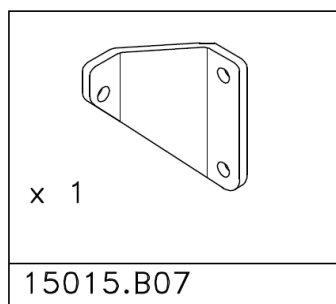
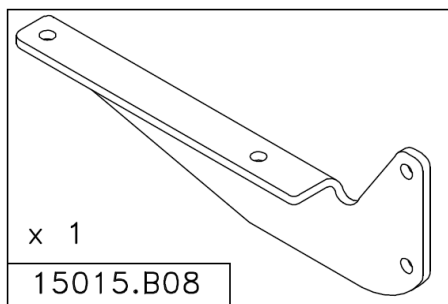

REV.00

15015/C

|   |    |              |
|---|----|--------------|
| ① | 1x | M12x85 (8.8) |
| ② | 1x | M12x25 (8.8) |
| ③ | 1x | M12x22 (8.8) |
| ④ | 3x | 12.2x27x2.5  |
| ⑤ | 1x | M12 (8.8)    |

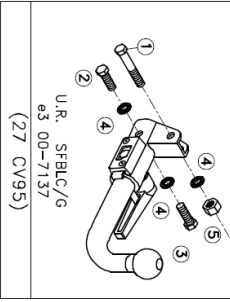

|   |    |         |                |                |                |           |     |
|---|----|---------|----------------|----------------|----------------|-----------|-----|
| ① | 1x | M10x100 | 10x40x2        | 10x40x2        | φ17x2 Lg. 72mm | 10x22x1,5 | M10 |
| ② | 1x | M10x100 | 10x40x2        | φ17x2 Lg. 60mm | 10x22x1,5      | 10x22x1,5 | M10 |
| ③ | 1x | M8x25   | 8x18x1,4       |                |                |           |     |
| ④ | 1x | M10x100 | φ17x2 Lg. 60mm | 10x22x1,5      | M10            |           |     |
| ⑤ | 1x | M10x100 | φ17x2 Lg. 60mm | 10x22x1,5      | M10            |           |     |
| ⑥ | 1x | M10x40  | φ17x2 Lg. 10mm | 10x22x1,5      | M10            |           |     |
| ⑦ | 2x | M10x35  | 10x22x1,5      | M10            |                |           |     |
| ⑧ | .  | M12     |                |                |                |           |     |

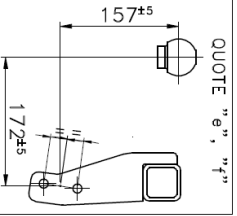
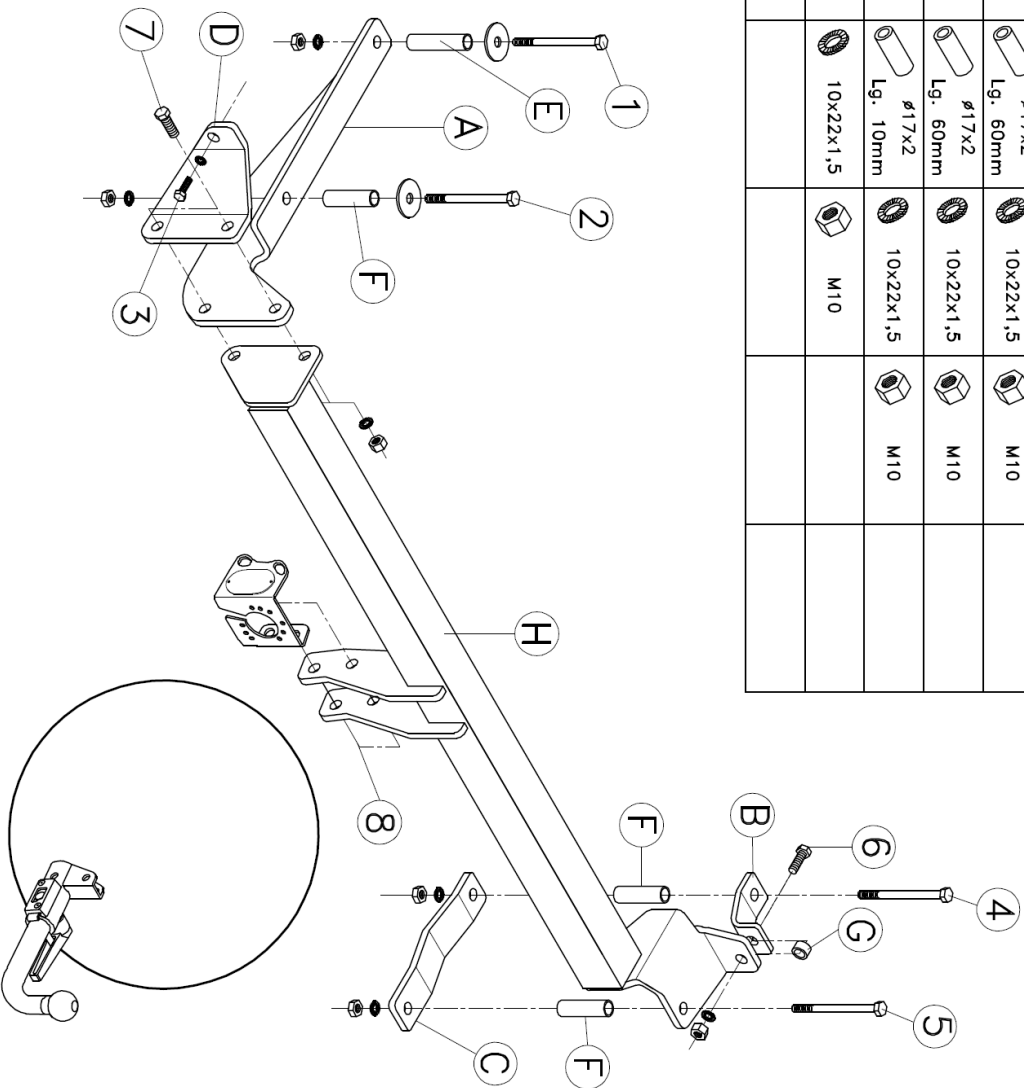

QUOTE "e", "f"

REV.00

**TAGLIO PARAURTI  
BUMPER'S CUT  
DÉCOUPE PARE-CHOCS  
AUSSCHNITT STOBSTANGE  
РАЗРЕЗ БАМПЕРА  
РОЗРІЗ БАМПЕРУ**

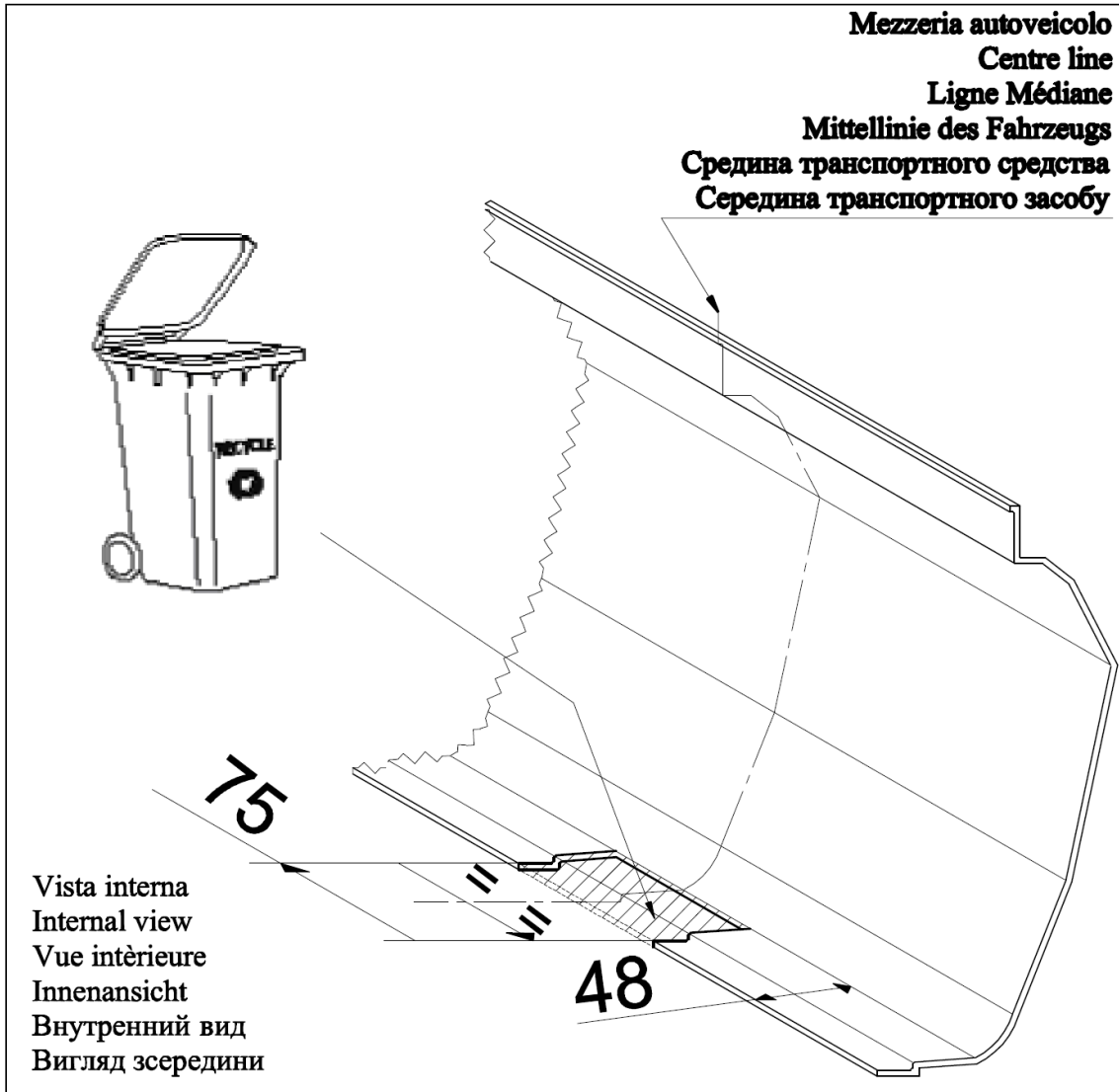

# MECCANISMO MOD. C 2007



tel. +39 075 5280260  
 fax +39 075 5287033  
[www.umbrazimorchi.it](http://www.umbrazimorchi.it)  
[umbrazimorchi@umbrazimorchi.it](mailto:umbrazimorchi@umbrazimorchi.it)

|               |                 |               |
|---------------|-----------------|---------------|
| NL - Montage  | S - Montering   | I - Montaggio |
| GB - Mounting | DK - Tilkobling |               |
| D - Montage   | FIN - Asennus   |               |
| F - Montage   | E - Montaje     |               |

|                 |                 |                |
|-----------------|-----------------|----------------|
| NL - Demontage  | S - Demontering | I - Smontaggio |
| GB - Disounting | DK - Frakobling |                |
| D - Demontage   | FIN - Irrota    |                |
| F - Démontage   | E - Desmontaje  |                |

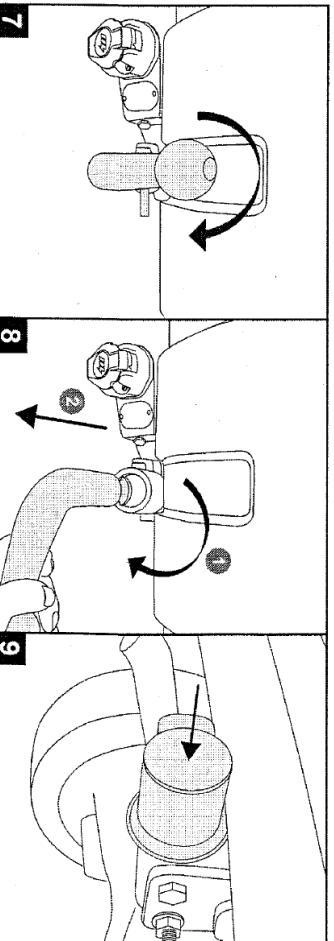
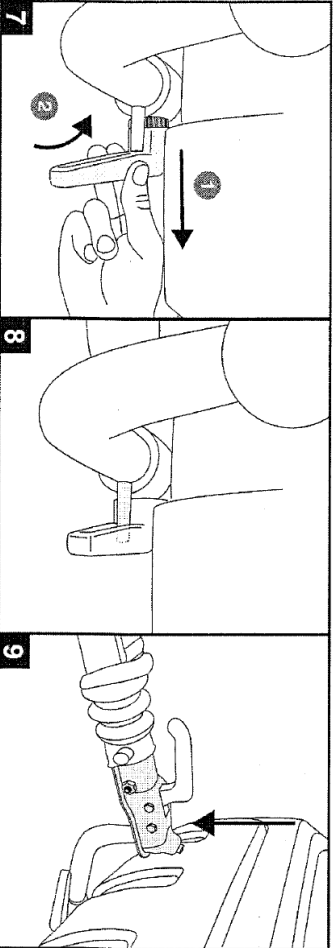
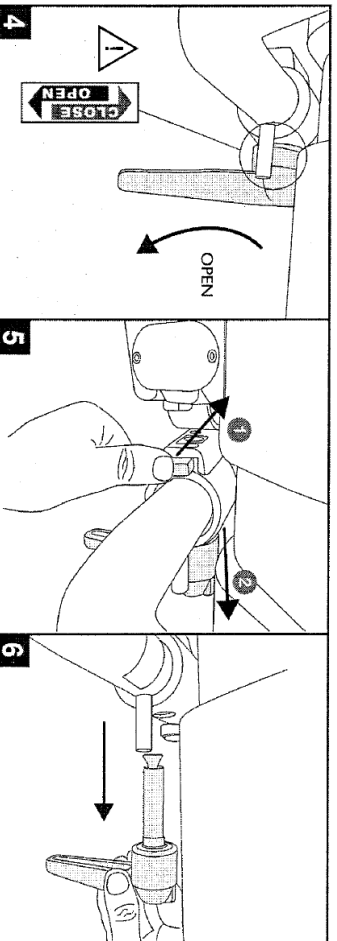
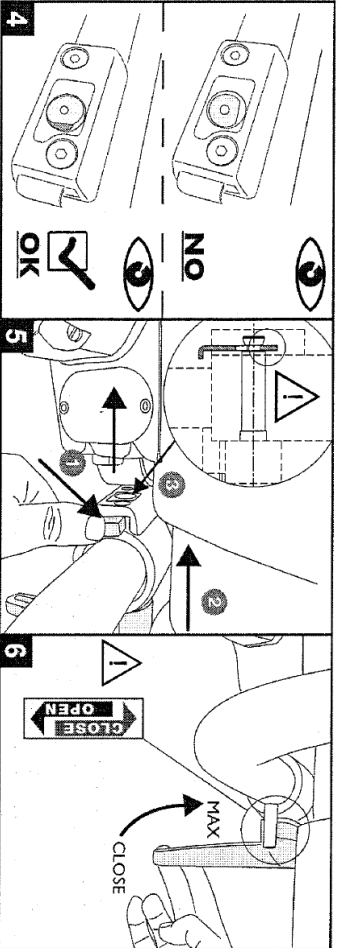
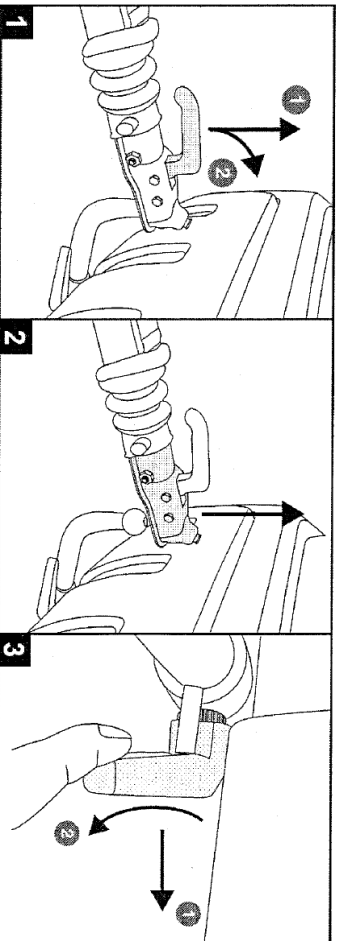
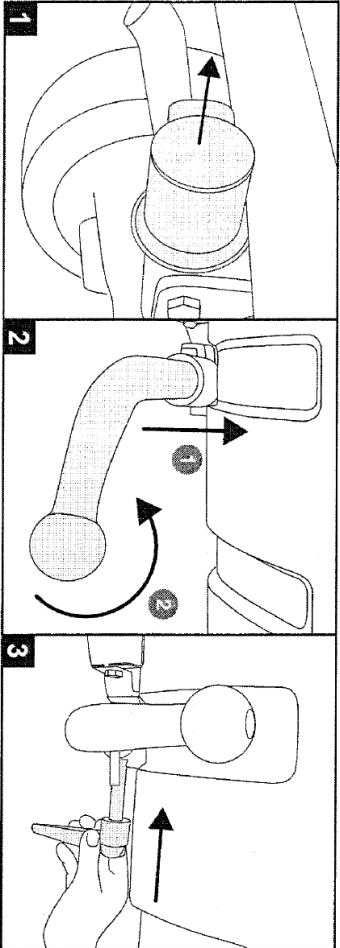

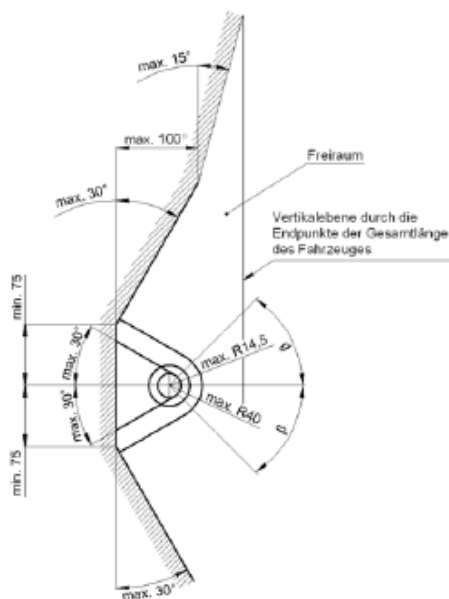
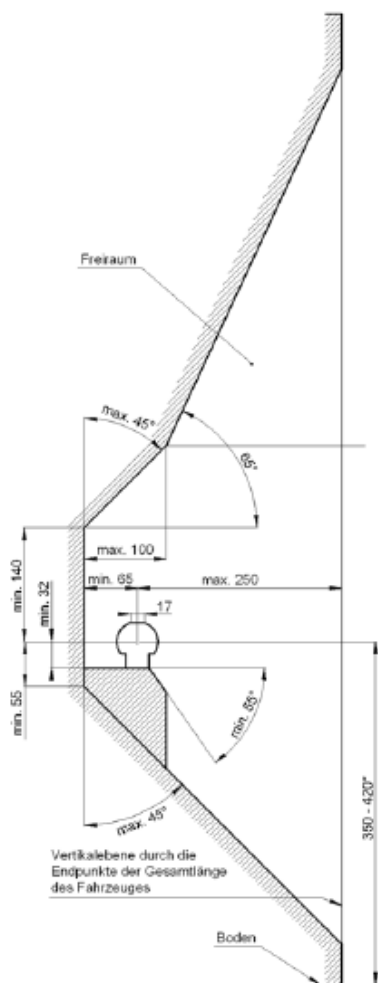

- D** Der Freiraum nach Anhang 7, Abbildung 25a und 25b der Richtlinie ECE-R 55 ist zu gewährleisten.
- CZ** Volný prostor ve smyslu Přílohy VII, obr. 25a a 25b směrnice ECE-R 55 musí být zaručen.
- DK** Det skal sikres, at der er spillerum i overensstemmelse med bilag 7, fig. 25a og 25b i henhold til direktiv ECE-R 55.
- E** Hay que garantizar el espacio libre conforme al anexo 7, fig. 25a y 25b de la directiva ECE-R 55.
- F** La zone de dégagement, selon l'annexe 7, figure 25a et 25b de la directive ECE-R 55, doit être assurée.
- FIN** Välyksen tulee täyttää ohjeen ECE-R 55 liitteen 7 kuvissa 25a ja 25b ilmoitetut vaatimukset.
- GB** Make sure to provide clearance according to appendix 7, figures 25a and 25b of the ECE-R 55 regulations.
- GR** Πρέπει να εξασφαλιστεί ο ελεύθερος χώρος σύμφωνα με το παράρτημα 7, σχήμα 25a και 25b της κοινοτικής οδηγίας ECE-R 55.
- HU** Biztosítani kell az ECE-R 55 irányelv szerinti, 7. számú függelék, 25a. és 25b ábrákban jelölt szabad teret.
- I** Deve essere garantito lo spazio libero secondo l'allegato VII, figure 25a e 25b della normativa europea ECE 55 R-01.
- N** Det må sikres for fritt rom i samsvar med tillegg 7, figur 25a og 25b i direktiv ECE-R 55.
- NL** De vrije ruimte volgens supplement 7, afbeelding 25a en 25b van richtlijn ECE-R 55 moet gewaarborgd zijn.
- PL** Należy zapewnić wolną przestrzeń zgodnie z załącznikiem 7, rys. 25a i 25b, dyrektywy ECE-R 55.
- RUS** Оставлять свободное пространство согласно Приложению 7, рис. 25a и 25b Директивы ECE-R 55.
- S** Spelrummet enligt bilaga 7, bild 25a och 25b i riktlinje ECE-R 55, måste garanteras.

- D** \* bei zulässigem Gesamtgewicht des Fahrzeuges
- CZ** \* při celkové přípustné hmotnosti vozidla
- DK** \* ved tilladt totalvægt for køretøjet
- E** \* con peso total autorizado del vehículo
- F** \* pour poids total en charge autorisé du véhicule
- FIN** \* Ajoneuvon suurimmalla sallitulla kokonaispainolla
- GB** \* at gross vehicle weight rating
- GR** \* για το επιτρεπτό μικό βάρος του οχήματος
- HU** \* A jármű megengedett összsúlya esetén
- I** \* per il peso complessivo ammesso del veicolo
- N** \* ved kjøretøyet's tillatte totalvekt
- NL** \* bij toegestaan totaal gewicht van het voertuig
- PL** \* przy dopuszczalnym ciężarze całkowitym pojazdu
- RUS** \* при допустимом общем весе автомобиля
- S** \* vid fordonets tillåtna totalvikt





[ahkupplungen.de](http://ahkupplungen.de)